

THE INFORMATION CONTAINED IN THIS DRAWING IS THE SOLE PROPERTY OF CORNERFILL®. ANY REPRODUCTION IN PART OR WHOLE WITHOUT THE WRITTEN PERMISSION OF CORNERFILL® IS PROHIBITED.

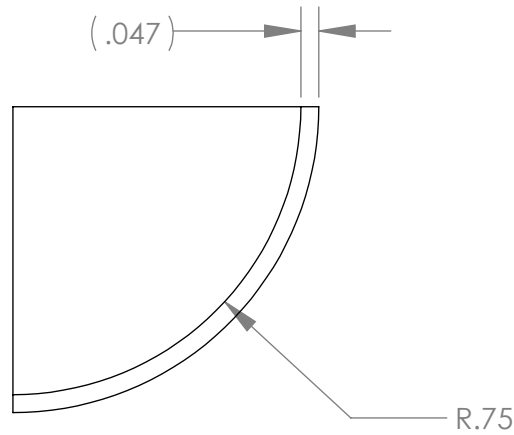

UNLESS OTHERWISE SPECIFIED
DIMENSIONS ARE IN INCHES
TOLERANCES ARE:
FRACTIONS DECIMALS ANGLES
±1/16 .XX ±.03 ± 1°
.XXX ±.010

CAD GENERATED DRAWING,
DO NOT MANUALLY UPDATE

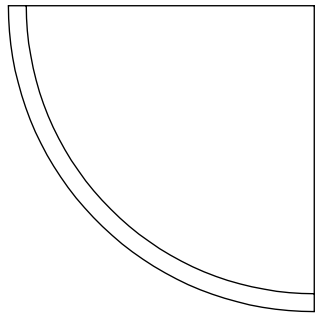
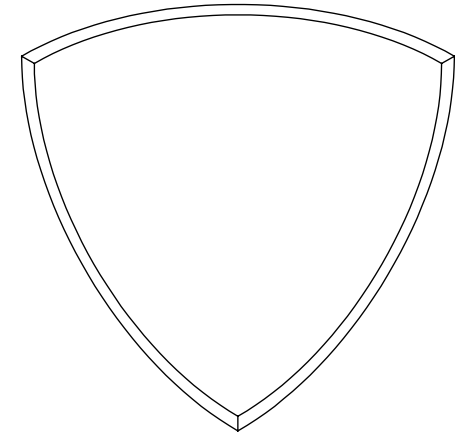
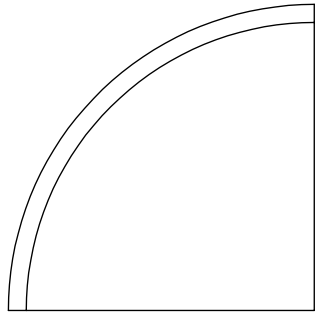

APPROVALS		DATE
DRAWN	JOHN S.	01-06-17
CHECKED	SS	01-07-17
RESP ENG		
MFG ENG		
QUAL ENG		

MATERIAL
18 GA 304 CRES
FINISH
TUMBLE DEBURR
DO NOT SCALE DRAWING

WELD IN CORNER 3/4"
18 GA 304 CRES

SIZE A	DWG. NO. 100403	REV. A
SCALE	CAD FILE: -100403	SHEET 1 OF 1

NOTES: 1. AVAILBLE AT WWW.CORNERFILL.COM